

INDOOR

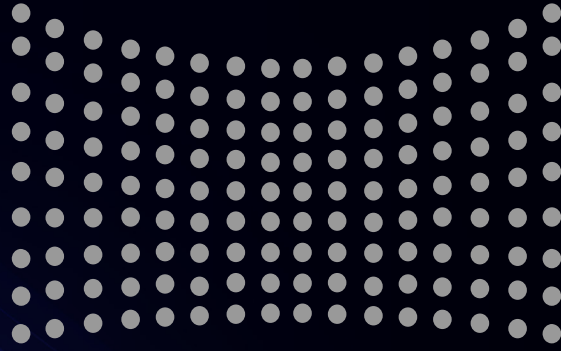

LED MEDIA GROUP

Display Technology

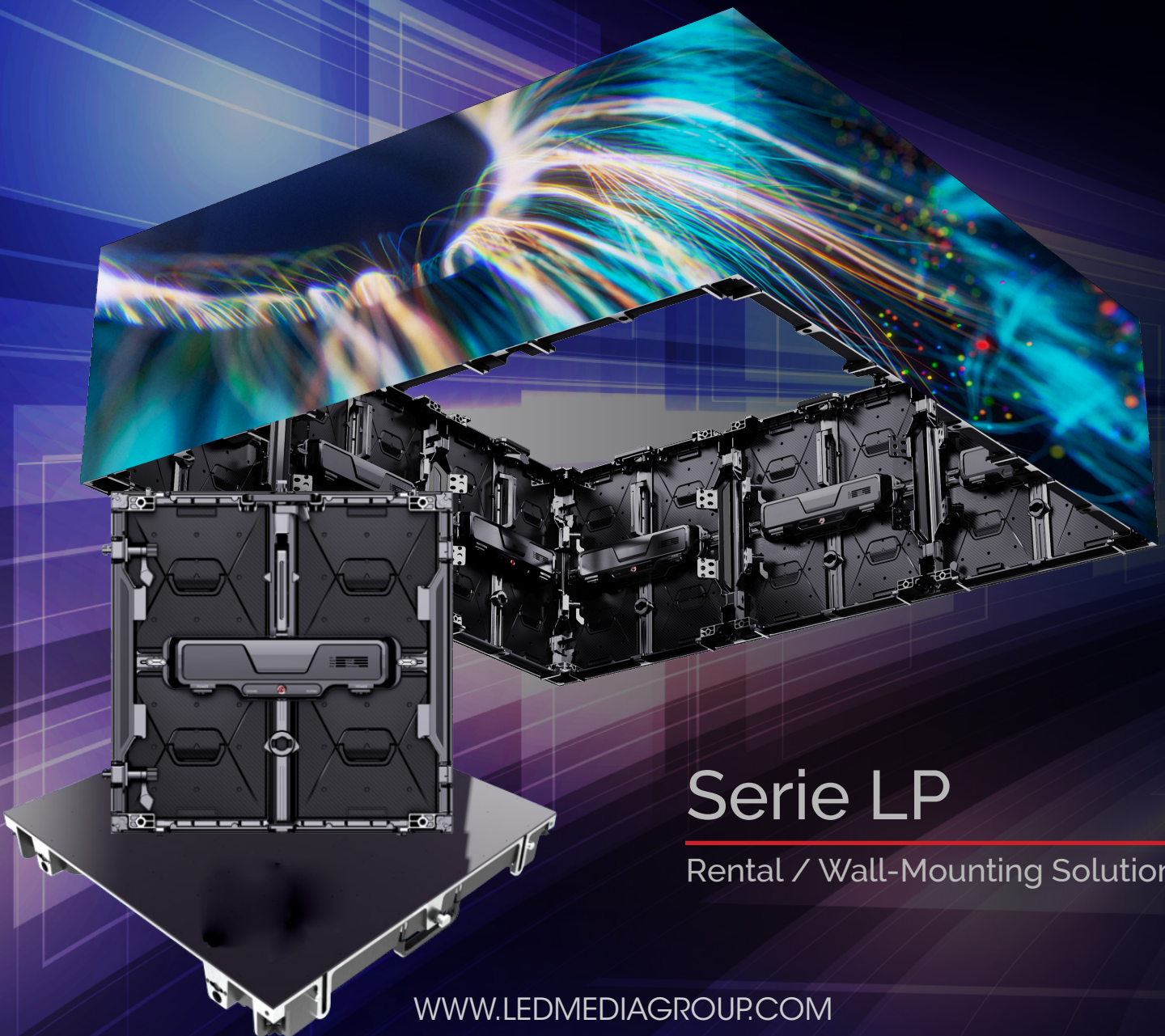

Serie LP

Rental / Wall-Mounting Solution

WWW.LEDMEDIAGROUP.COM



Ultra-thin wall-mounting solution.

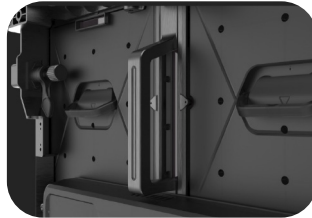

Integrated Design of die-cast aluminium handle, more durable.

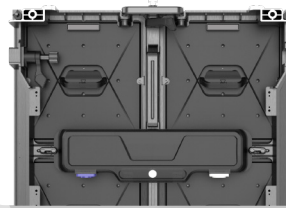

Only 5 kg weight and 64 mm thickness.



Anti Collision coating design for 4 edges.

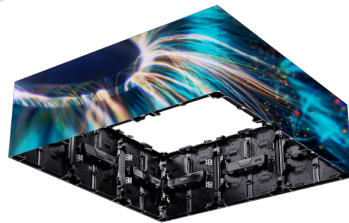

90° Corners.



Floor Installation with steel structure.

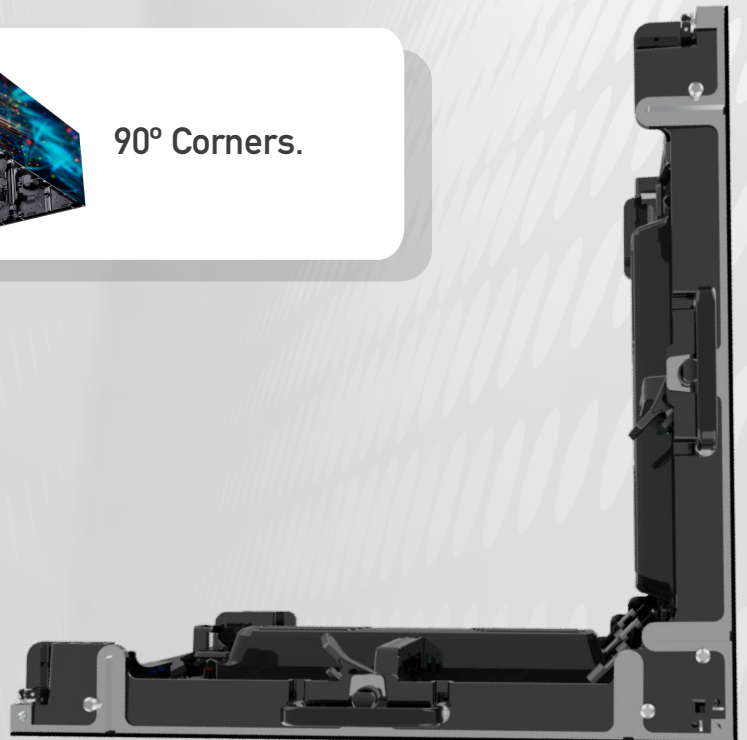



SPECIFICATION CAN BE CUSTOMIZED

Model Number	LP1.9	LP2.6	LP2.9
Pixel Pitch	1.9mm	2.6mm	2.9mm
LED Type	SMD1515	SMD1515	SMD1515
Pixel Configuration	1R1G1B	1R1G1B	1R1G1B
Size of Module	250*250mm/9.84*9.84 Inches		
Resolution of Module	128*128	96*96	84*84
Resolution of Cabinet	256*256	192*192	168*168
Density (dots/m ²)	262144	147456	112896
Size of Cabinet	500*500*64mm/19.69*19.69*2.52 Inches		
Cabinet Material	Die-Casting	Die-Casting	Die-Casting
Weight of Cabinet	5Kg/11 lbs		
Max Power Consumption	≥450W/m ²	≥450W/m ²	≥450W/m ²
Average Power Consumption	≥150W/m ²	≥150W/m ²	≥150W/m ²
Gray scale	14-16bits	14-16bits	14-16bits
Color Temperature	6500-8000K	6500-8000K	6500-8000K
Refresh Frequency	≥3840hz	≥3840hz	≥3840hz
Brightness	800cd/m ²	800cd/m ²	800cd/m ²
Brightness Control	256 Grade	256 Grade	256 Grade
IP Grade	IP30	IP30	IP30

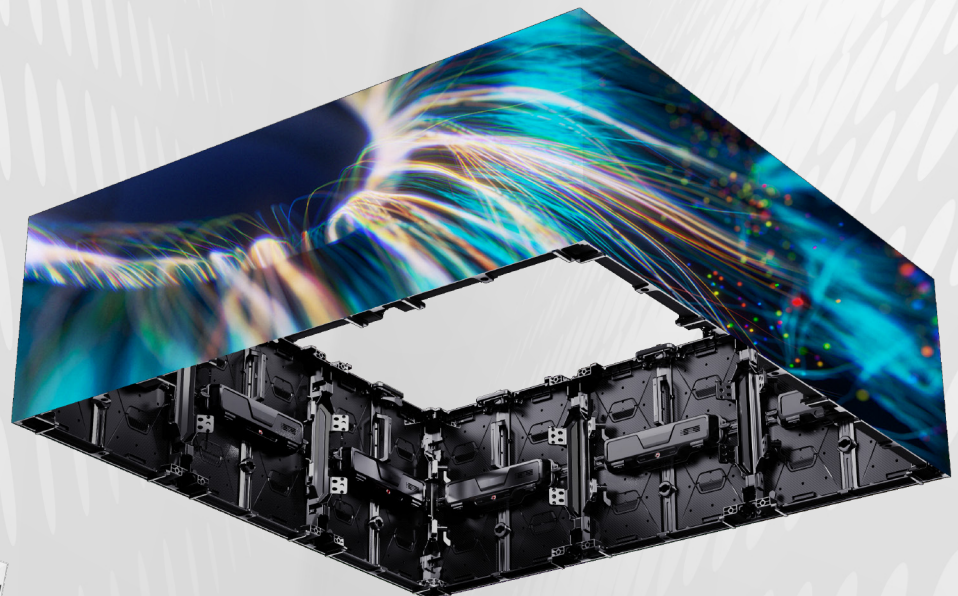
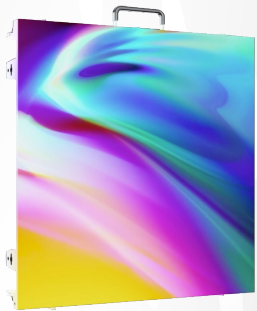

+1 800 548 4907 / +1 305 974 5875 

+ 1 305 340 1396 

20815 NE 16 Ave. B6, Miami, Florida. 33179 

info@ledmediagroup.com 

www.ledmediagroup.com 